

Charles

VALENTINI



Dimensioni

Dimensions - Masse - Dimension - Tamaño

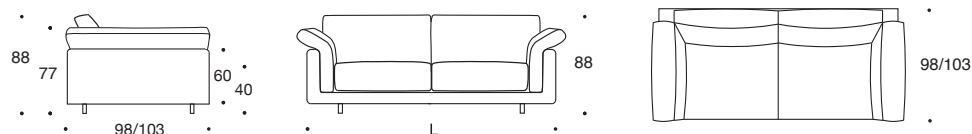

Profondità seduta 60 cm - Seat depth 57 cm - Profondeur du siège 60 cm - Sitztiefe 60 cm - Profundidad del asiento 60 cm

Piedini

Metallo finitura verniciato nero opaco H. 12,5 cm

Legs: Matt black painted metal

Pieds: Métal peint en noir mat

Fuesse: Mattschwarz lackiertes Metall

Pies: Acabado pintado negro mate metal

Cuciture optional

Sewings - Naehte - Coutures - Costuras



Chiusa
Closed
Feste Naht
Couture fermée
Costura cerrada



Bordo canneté colorato
Piping with colored
gross grain - Passepoil
avec gross grain
coloré - Keder mit
buntem Gross Grain -
canneté coloreado

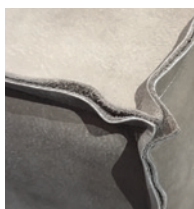

Bordo al vivo (pelle)
Open cut sewing
(leather) Couture ouverte
(cuir) Offenkantige Naht
(Leder) Costuras abiertas
(cuero)



Bordo a coda di topo
Piping
Passepoil
Keder
Ribete

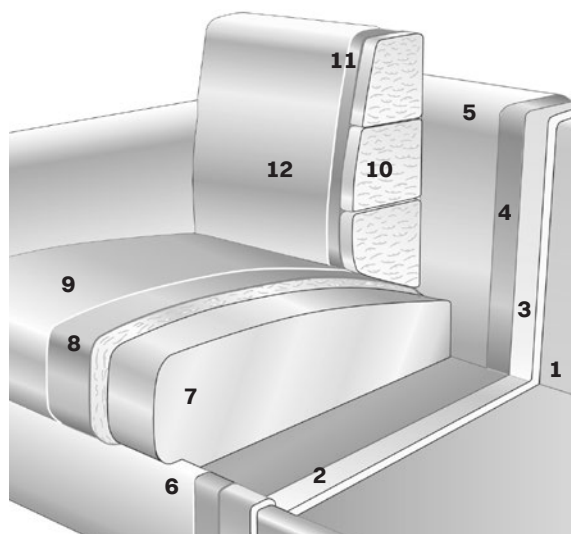

Struttura

Structure - Struktur Structure - Estructura

1. Fusto legno

Wood structure - Structure en bois
Holzstruktur - Estructura de madera

2. Fondo scocca in legno

Base structure in wood
La base de la structure en bois
Basis der Struktur in Holz
La base de la estructura de madera

3. Gomma

Foam - Poliurethanschäum
Mousse - Poliuretano

4. Rivestimento

Cover - Bezug - Housse
Revestimiento

5. Tessuto sfoderabile

Removable fabric - Stoff déhoussable -
Tissu abziehbar - Tela amovible

Cuscino seduta

Seat cushion - Sitzkissen
Coussin de siège - Cojín del asiento

6. Cuscino ad incastro con antiscivolo

No-slip seat cushion
Coussin d'assise antidérapant
Rutschfeste Sitzkissen
Cojines de sentada antidesliz

7. Gomma a quote differenziate con materassino superiore in misto piuma divisa a scomparti

Polyurethane foam with a top in eather mix split into compartments -
Mousse en polyuréthane avec de différentes densités et un matelas mélange de plume divisé en sections - Polyurethanschäum mit unterschiedlicher Dichte mit Matte in Federmischung in Kassetten unterteilt -
Goma de diferentes densidades con colchón superior en mezclado de pluma dividido en secciones

8. Tela cotone bianco e fibra

White cotton linen and fibre - Tissu et fibres de coton blanc - Weißes Baumwollgewebe und Faser
Tela y fibra de algodón blanco

9. Tessuto sfoderabile

Removable fabric - Stoff déhoussable
Tissu abziehbar - Tela amovible

Cuscino schienale

Back cushion - Rueckenkissen
Coussins de dossier - Cojines de respaldo

10. Piuma sterilizzata e siliconata

Sterilized and siliconized feather Mix
Stérilisés et siliconés mix des plumes
Sterilisierte und mit Silikon behandelte Federmischung -
Mix de pluma esterilizada y silicona

11. Tela cotone bianco

White cotton linen - Tissu de coton blanc - Baumwolltuchstoff weiß
Algodón blanco

12. Tessuto sfoderabile

Removable fabric - Stoff déhoussable
Tissu abziehbar - Tela amovible

Seduta antiscivolo

Anti-slip seat cushion
Coussine de siège antidérapant
Rutschfestes Sitzkissen
Cojines de sentada antidesliz

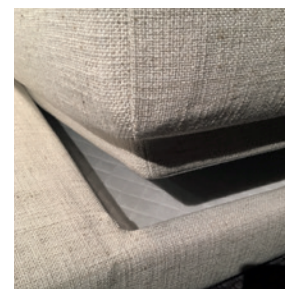

Charles

VALENTINI

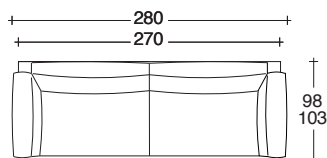

OC01

Divano 4 posti
Sofa 4 seaters
Canapé 4 places
Sofa 4-Sitzer
Sofa 4 asientos



kg



m³ 2,24



m 17,5

Fodera di ricambio
SpareCover
Housse deréchange
Ersatzbezug
Funda

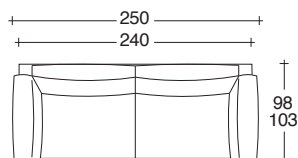

OC02

Divano 3 posti
Sofa 3 seaters
Canapé 3 places
Sofa 3-Sitzer
Sofa 3 asientos



kg



m³ 2,00



m 15,50

Fodera di ricambio
SpareCover
Housse deréchange
Ersatzbezug
Funda

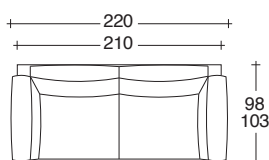

OC03

Divano 2 posti
Sofa 2 seaters
Canapé 2 places
Sofa 2-Sitzer
Sofa 2 asientos



kg



m³ 1,76



m 14,00

Fodera di ricambio
SpareCover
Housse deréchange
Ersatzbezug
Funda

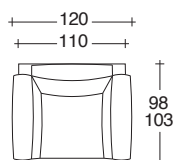

OC04

Poltrona
Armchair
Fauteuil
Sessel
Butaca



kg



m³ 1,00



m 10,00

Fodera di ricambio
SpareCover
Housse deréchange
Ersatzbezug
Funda

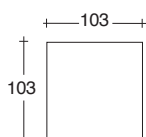

OC05

Pouff quadro
Square Pouff
Pouff carré
Quadratischer Pouff
Pouff quadrado



kg



m³ 0,50



m 5,00

Fodera di ricambio
SpareCover
Housse deréchange
Ersatzbezug
Funda